



ILLUMINAZIONE



# ILLUMINAZIONE

- 216 SHINING CURB®
- 226 SHINING CURB PUNTUALI®
- 236 VENETO LIGHT®

# SHINING CURB®

DESIGNERS

## STUDIO RIGO - 2018



### Un percorso creativo e illuminante.

È il percorso compiuto da Studio Rigo per approdare a Shining Curb®: un cordolo con Led che funge al contempo da lampada per esterno, emanando un'illuminazione indiretta radente il suolo, ben omogenea ed inclinata in modo da impedire di abbagliare. Una lampada minimal, perfetta per l'arredo outdoor di classe.

A path creative and enlightening. This is the path taken by Studio Rigo to arrive at Shining Curb®: a curb with LED that acts as an outdoor lamp at the same time, giving off lighting indirect grazing the ground, well homogeneous and inclined in order to prevent dazzle. A minimal lamp, perfect for classy outdoor furniture.

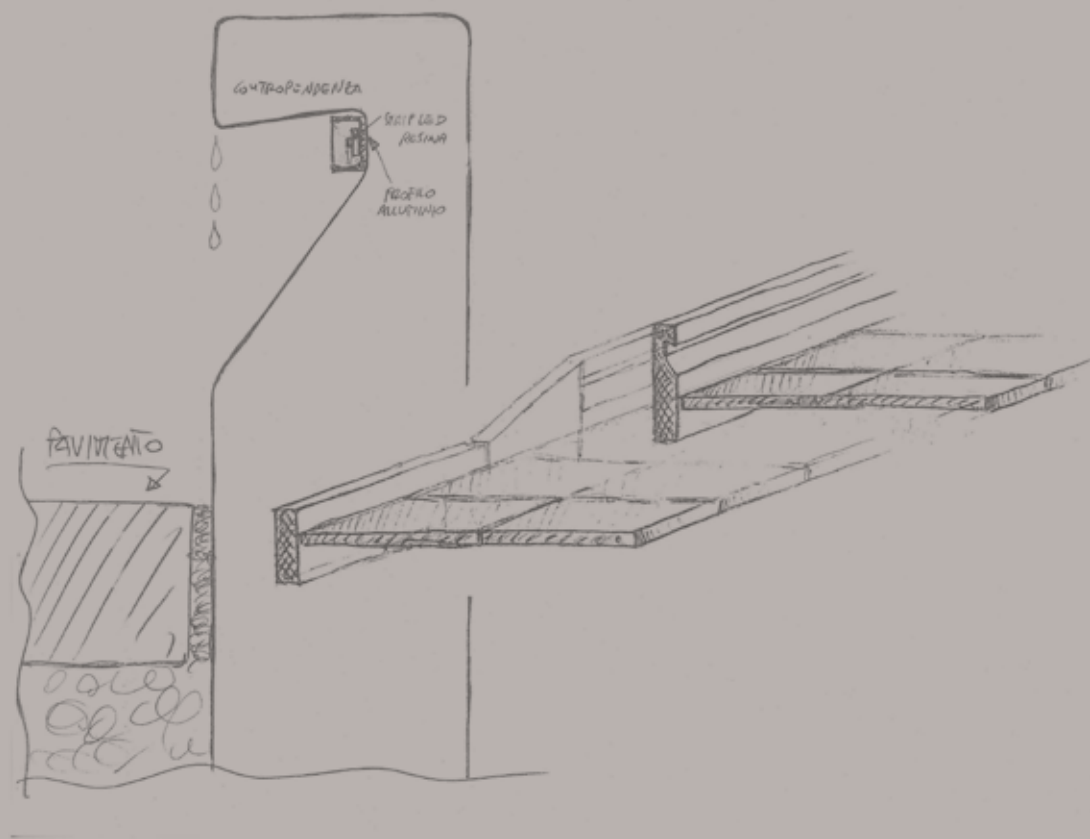

Il design minimale del cordolo in calcestruzzo, fa sì che esso non sia visibile durante il giorno per poi comparire solo con l'oscurità. L'abbinamento tra cordolo calpestabile e fonte di luce, rende Shining Curb® un sistema di illuminazione per esterno in grado di assolvere anche alle funzioni di contenimento del verde, ideale sia in ambiti pubblici che privati.

The minimal design of the concrete curb means that it is not visible during the day and then appear only with darkness. The combination of walkable curb and light source makes Shining Curb® a outdoor lighting system able to also perform the functions of containment of the green, ideal in both public and private environments.

# SHINING CURB®

STUDIO RIGO - 2018

Design brevettato / Patented design













Di giorno quasi invisibile, protagonista la sera.  
Presenza minimale, versatilità infinita.

Almost invisible during the day, protagonist in the evening.  
Minimal presence, infinite versatility.

# SHINING CURB®

STUDIO RIGO - 2018

Design brevettato / Patented design

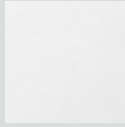

Bianco perla  
Pearl white



Grigio chiaro  
Light grey

LAMPADA CHIUSA E LAMPADA CONTINUA  
CLOSED LAMP AND CONTINUOUS LAMP

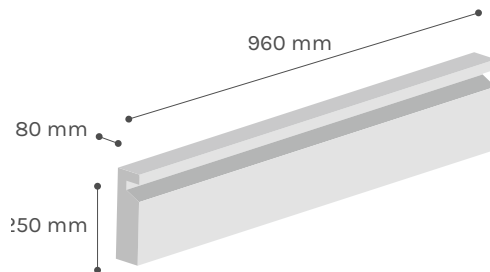
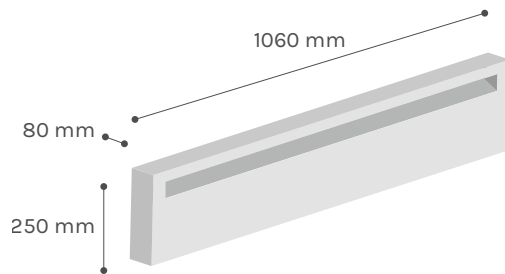

TERMINALE CONTINUO E TERMINALE PER LIVELLO ZERO  
CONTINUOUS TERMINAL AND TERMINAL FOR ZERO LEVEL

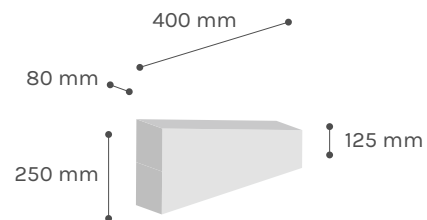
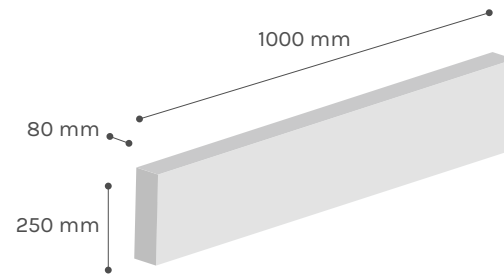

# SHINING CURB® project

Complesso di abitazioni private "Monte Rosa"  
Varese

**Arch. Franco Mastroianni**





# SHINING CURB PUNTUALI®

DESIGNERS

**STUDIO RIGO - 2020**



## **Definire la luce in ogni punto.**

Se per la particolare conformazione di un giardino - o di un camminamento - i còrdoli con Led della linea Shining Curb® non giungessero ad illuminare sufficientemente alcune zone, la gamma dei puntuali è subito pronta per fornire la sua integrazione. Una serie di punti luce che inoltre valorizza ulteriormente il percorso, con il suo design curato, raffinato, essenziale.

Define the light at every point. If for the particular shape of a garden - or a walkway - the curbs with LEDs of the Shining Curb® line did not come to illuminate sufficiently some areas, the range of punctuals is immediately ready to provide its integration. A series of light points that also further enhances the path, with their own refined essential design.

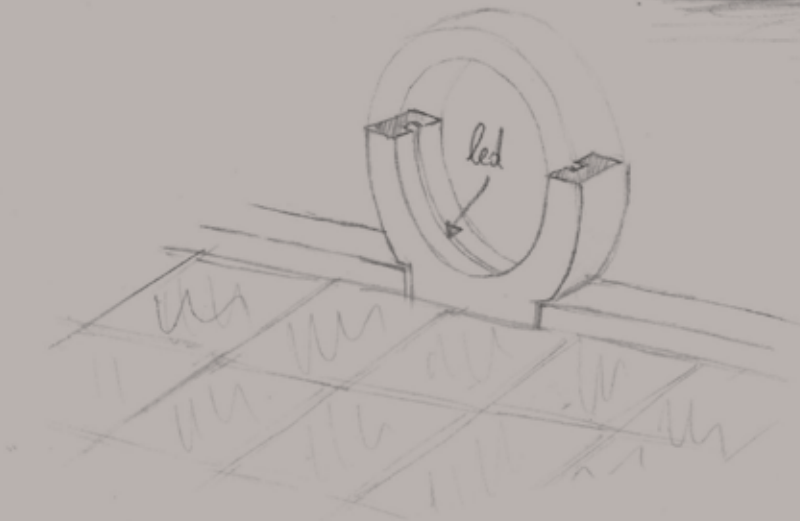

I punti luce Shining Curb® consentono di diffondere la luce nel modo desiderato, ponendosi a complemento delle grandi lampade orizzontali che emanano l'illuminazione radente il suolo. Da questa integrazione, nascono allestimenti sempre perfetti, personalizzati nel minimo dettaglio.

The Shining Curb® light points allow you to diffuse the light in the desired way, complementing it of the large horizontal lamps that emanate the lighting grazing the ground. From this integration, always perfect set-ups are born, customized in the smallest detail.

# SHINING CURB PUNTUALI®

STUDIO RIGO - 2020

Design brevettato / Patented design



**SHINING CURB PUNTUALI®**

**SOLE**

Bianco perla - Pearl white

Grigio chiaro - Light grey









**SHINING CURB PUNTUALI®  
SIRIO**

Bianco perla - Pearl white  
Grigio chiaro - Light grey



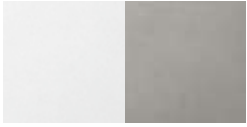

**SHINING CURB PUNTUALI®  
ANTARES**

Bianco perla - Pearl white  
Grigio chiaro - Light grey

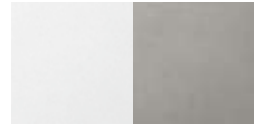

**SHINING CURB PUNTUALI®  
VEGA**

Bianco perla - Pearl white  
Grigio chiaro - Light grey



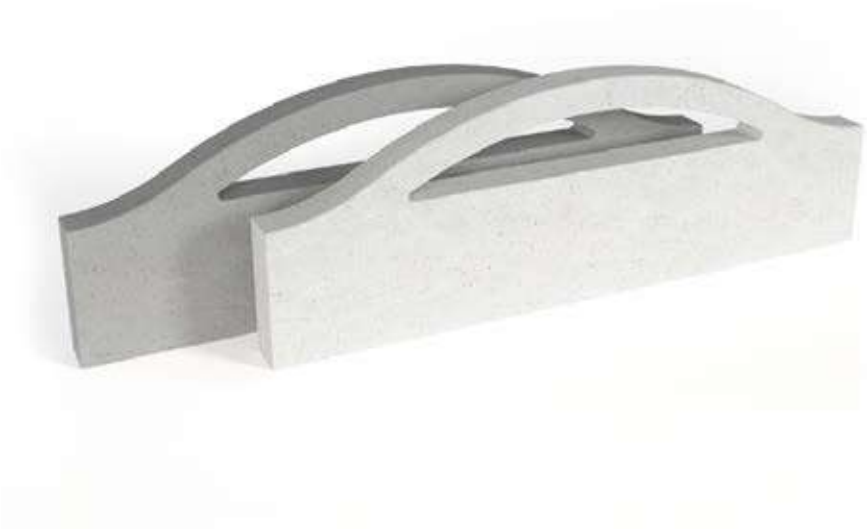

# SHINING CURB PUNTUALI®

STUDIO RIGO - 2020

Design brevettato / Patented design

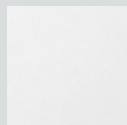

Bianco perla  
Pearl white

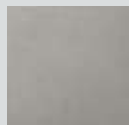

Grigio chiaro  
Light grey

SIRIO

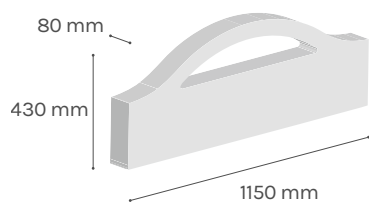

VEGA

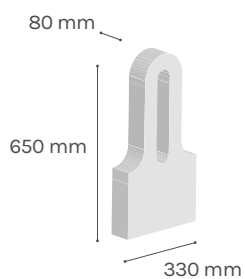

ANTARES

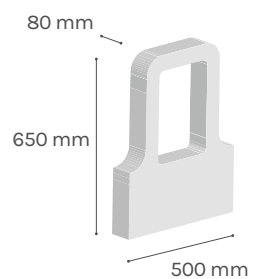

SOLE

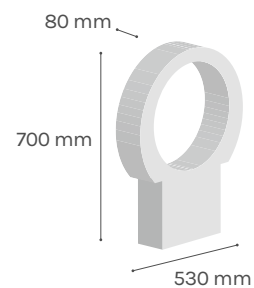

# VENETO LIGHT®

DESIGNERS

## STUDIO RIGO - 2018



### **In corten o in acciaio: comunque in bellezza.**

Studio Rigo ha pensato anche ad una versione di lampade per illuminazione a pavimento dallo stile diverso: Veneto Light®, infatti, arreda gli spazi outdoor con la scintillante pulizia delle finiture in acciaio inox, oppure con il calore pastoso dell'acciaio corten. Soluzioni diverse ma accomunate dall'essenzialità formale, per un'eleganza sobria, sempre esclusiva.

Corten or steel: however in beauty. Studio Rigo has also thought of a version of lamps for lighting a floor with a different style: Veneto Light®, in fact, furnishes outdoor spaces with the sparkling cleanliness of the stainless steel finishes, or with pasty heat of corten steel. Different solutions but united by formal essentiality, however a sober elegance, always exclusive.



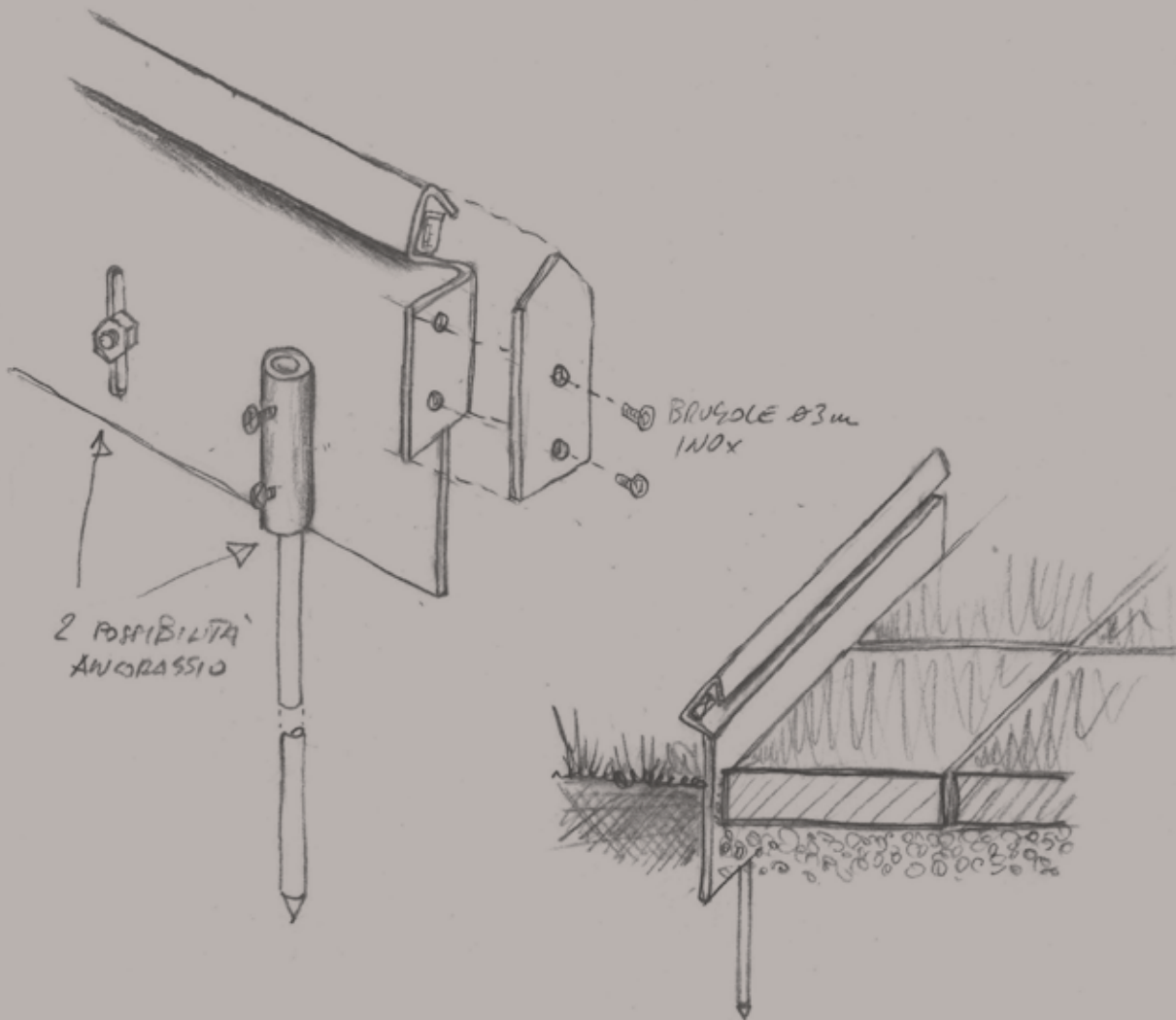
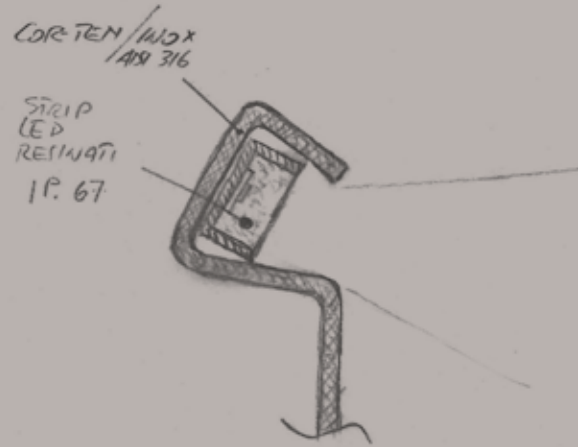

Veneto Light® consente di allestire un'illuminazione sempre calibrata su esigenze precise, per gli esterni di un'abitazione di classe come per il giardino dell'esercizio commerciale raffinato. Tra il gran numero di soluzioni personalizzabili, vi è la possibilità di scegliere le lampade nella versione con fissaggio al suolo mediante picchetto, oppure con ancoraggio al massetto.

Veneto Light® allows you to set up lighting that is always calibrated to specific needs, for the outdoors of a classy home as for the refined commercial garden. Among the large number of customizable solutions, there is the possibility to choose the lamps in the version with fixing to the ground by means of a stake, or anchored to the screed.

## VENETO LIGHT®

STUDIO RIGO - 2018

Design brevettato / Patented design









Linee di luce che evidenziano e valorizzano.  
Possibilità di combinazioni geometriche senza limite.

Lines of light that highlight and enhance.  
Possibility of geometric combinations without limits.

# VENETO LIGHT®

STUDIO RIGO - 2018

Design brevettato / Patented design

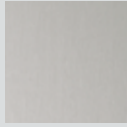

Acciaio INOX 304

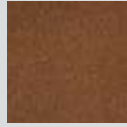

Corten

## SISTEMI DI FISSAGGIO

ANCORATO direttamente al bordo del pavimento.

PICCHETTO direttamente nel terreno.

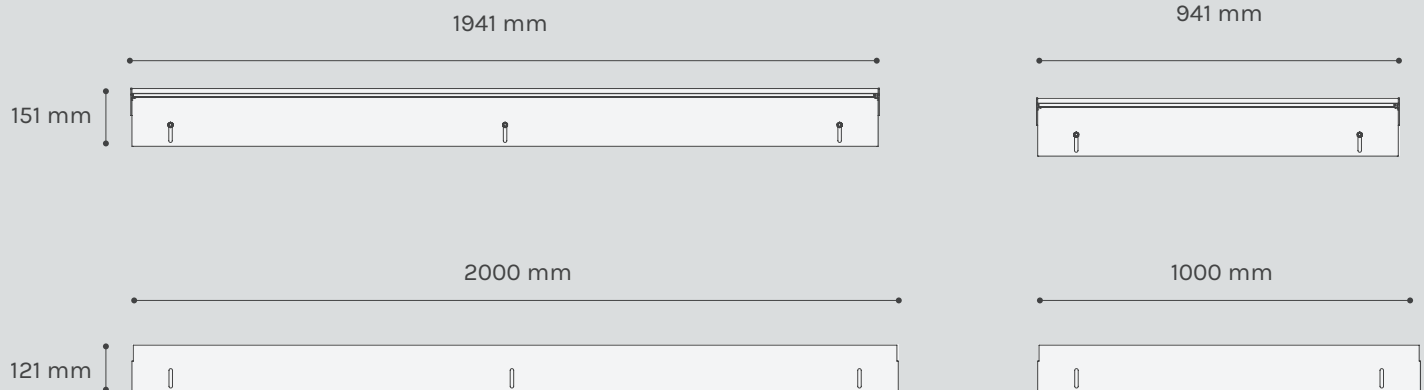
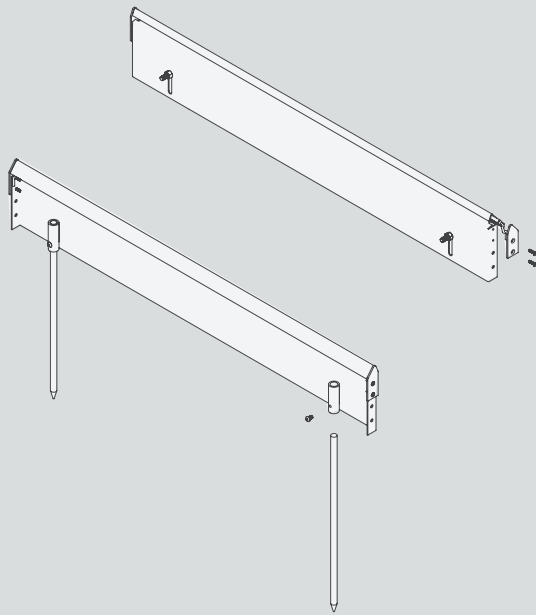

# VENETO LIGHT® project

Edificio residenziale  
Mogliano Veneto  
Treviso





Accesso edifici aziendali  
San Benedetto  
Scorzè  
Venezia

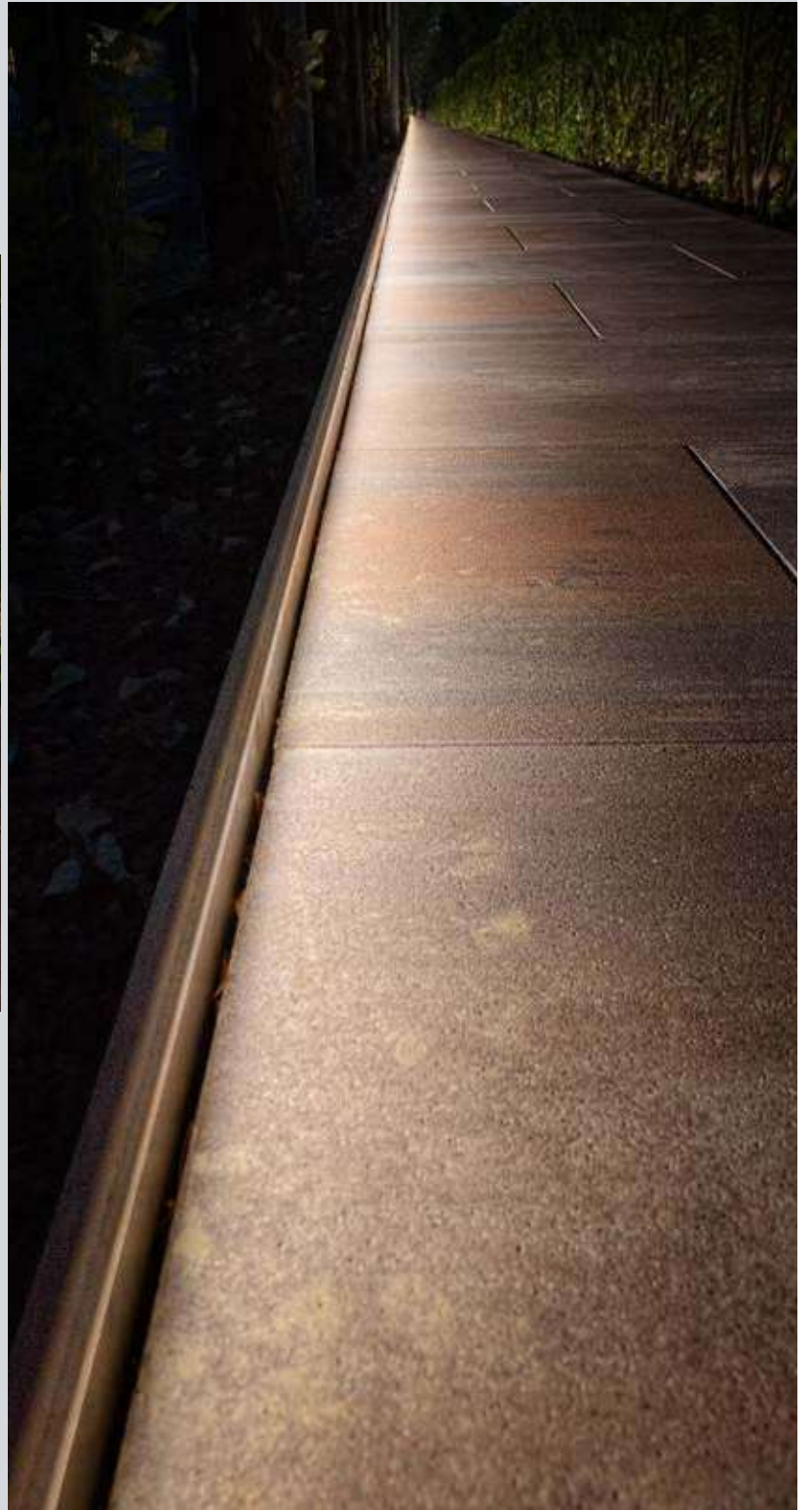

## CARATTERISTICHE TECNICHE

### QUARZO

I pavimenti quarzati sono realizzati con un'alta quantità di quarzo presente nell'impasto di finitura (strato di usura o superficie a vista). Questo pregiato aggregato conferisce al manufatto maggiore resistenza all'abrasione (classi di resistenza più elevate in base alla specifica normativa) e colori più vivi.

### QUARTZ

Il Quartz Color System (  ) è un sistema di produzione che si basa sull'unione di uno speciale impasto ad un caratteristico processo produttivo. L'impasto prevede un'introduzione di una certa quantità di quarzo per aumentare le prestazioni fisico-chimiche del prodotto e allo stesso tempo ne esalta le performance tecniche. Lo speciale processo produttivo crea invece una determinata impermeabilità tra l'elemento trattato e l'esterno, permettendo una pulizia agevolata della pavimentazione e una riduzione delle macchie rispetto ad un prodotto non trattato Quarz Color System. I colori resistono nel tempo in maniera più tenace esaltando il design della pavimentazione.

### BIOTANIO

Impasto di ultima generazione studiato dai nostri laboratori in grado di distruggere i composti organici che si possono depositare sulle lastre. Il Bio2tanio rende le lastre autopulenti e disinfettanti.

### LASTRE PRETRATTATE

Le lastre vengono fornite pretrattate con il trattamento "Protective stones"

### RESISTENZA ANTISDRUCCIOLO (R13+C)

Pavimentazioni sottoposte alla normativa tedesca DIN 51097 E DIN 51130 che ne esprime il grado di scivolosità rispettivamente a piedi nudi (Classe C) e a piedi calzati (R13). I prodotti che riportano questi simboli sono da considerarsi al massimo della sicurezza su luoghi pubblici e privati: piazze, contorni piscine, viali etc...

## TECHNICAL FEATURES

### QUARTZ

Quartz floors are made with a high quantity of quartz in the finishing mix (wear layer or visible surface). This high-quality aggregate gives the product greater resistance to abrasion (higher resistance classes according to the specific regulations) and more vivid colors.

### QUARTZ

The Quartz Color System (  ) is a production system based on the application of a special mixture to a characteristic production process. The mixture consists in the introduction of a certain amount of quartz to increase the physical-chemical performance of the product and at the same time enhances its technical performances. The special production process, on the other hand, creates a certain impermeability between the treated element and the exterior, allowing easier cleaning of the flooring and a reduction of stains compared to a non-treated Quarz Color System product. The colors resist over time more tenaciously enhancing the design of the flooring.

### BIOTANIO

Last generation concrete mix studied by our laboratories able to destroy the organic compounds that can be deposited on the slabs. Bio2tanio makes self-cleaning slabs and depolluting.

### PROTECTIVE STONE

The slabs are supplied pre-treated with the "Protective stones" treatment.

### SLIP RESISTANCE (R13+C)

Paving are based to the German regulation DIN 51097 and DIN 51130 that expression the anti-slip degree on bare feet (Class C) and with feet shod (R13). The product marked with this symbol are to be considered at maximum safety for applications either in public or private places.

## **SURFACES**

- 12 CERTOSA
- 90 GRAFFITI
- 136 GREEN CARPET NEST
- 122 KM+
- 78 MATERIA
- 44 MEGA
- 146 ONDE + ONDE LIVRE
- 100 RECYCLE
- 64 RIGA
- 30 TORCELLO

## **ARREDOURBANO**

- 196 COMBO
- 160 D'IVANO
- 168 NUVOLA
- 188 RELAX
- 182 SBALZO
- 176 SITTING
- 206 TREE-CYCLE

## **ILLUMINAZIONE**

- 216 SHINING CURB®
- 226 SHINING CURB PUNTUALI®
- 236 VENETO LIGHT®

# VIA VENETO®

EXCLUSIVE SURFACES

It's a brand of

**FAVARO1®**  
LIVING SURFACES

**FAVARO1 S.r.l.**  
Via Noalese, 79  
31059 Zero Branco TV - Italy  
T +39 0422 4868  
F +39 0422 487263



## CAM

Con la presente si dichiara che il contenuto di riciclato indicato nelle schede tecniche è certificato da ente terza accreditato ICMQ. La sabbia Rigenerata realizzata nella nostra unità produttiva di Zero Branco è un SOTTOPRODOTTO ai sensi dell'art. 184-bis comma 1) del Dlgs. 152/2006.

Nella continua ricerca di miglioramenti tecnici e funzionali, Favaro1 si riserva il diritto di apportare ai prodotti modifiche, anche sostanziali, che potranno essere effettuate senza alcun preavviso.

SHINING CURB® e VENETO LIGHT® sono brevetti registrati di proprietà di FAVARO1®. Tutti i diritti sono riservati.

VIA - VENETO . IT